



Joist

Designer Surround Installation Guide

Exclusively designed to fit these
European Home H Series Fireplaces:

HVF-42
HVF-42 ST

HVF-60
HVF-60 ST

HVF-72
HVF-72 ST

TABLE OF CONTENTS

Important Information	3
Specifications and Dimensions	5
Pre-Installation Planning	6
Installation	7
Maintenance	12
Warranty	13

IMPORTANT INFORMATION

PRODUCT INSTALLATION RECORD

Installer: Please complete this form.

Customer: Please retain this information.

Purchased From	
Date of Purchase	
Installed By	
Date of Installation	
Surround Serial Number	

Thank you for your purchase of a **Designer Surround for H Series!**

Your **Designer Surround for H Series** is designed to install, and perform similar to ceramic tile and should be installed by a professional.

Please refer to your dealer for additional information for professional installers .

JOIST SURROUND PANELS

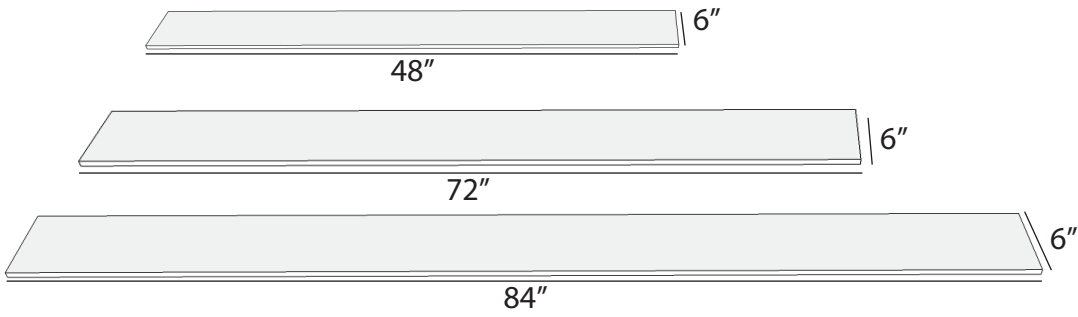
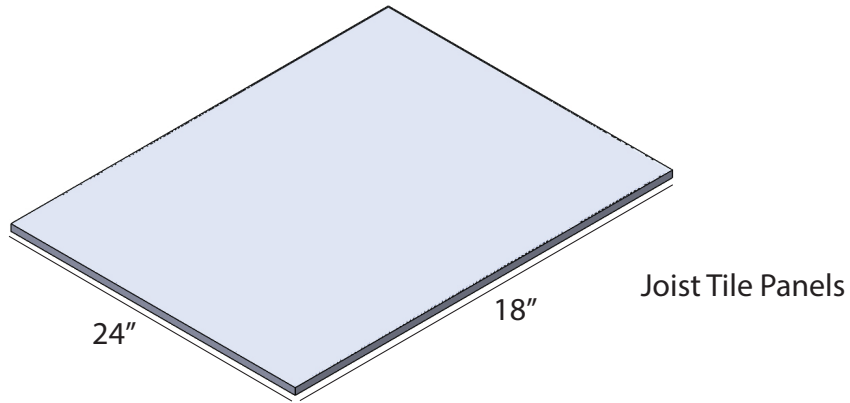

Joist Metal Panels

	48" Metal	72" Metal	84" Metal	24" Tile
42" Joist	-	1	2	1
60" Joist	4	-	1	1
72" Joist	6	-	-	1

Each surround contains Metal and Tile Panels according to the chart, above.
All surround panels are 7/16" thick

SPECIFICATIONS and DIMENSIONS

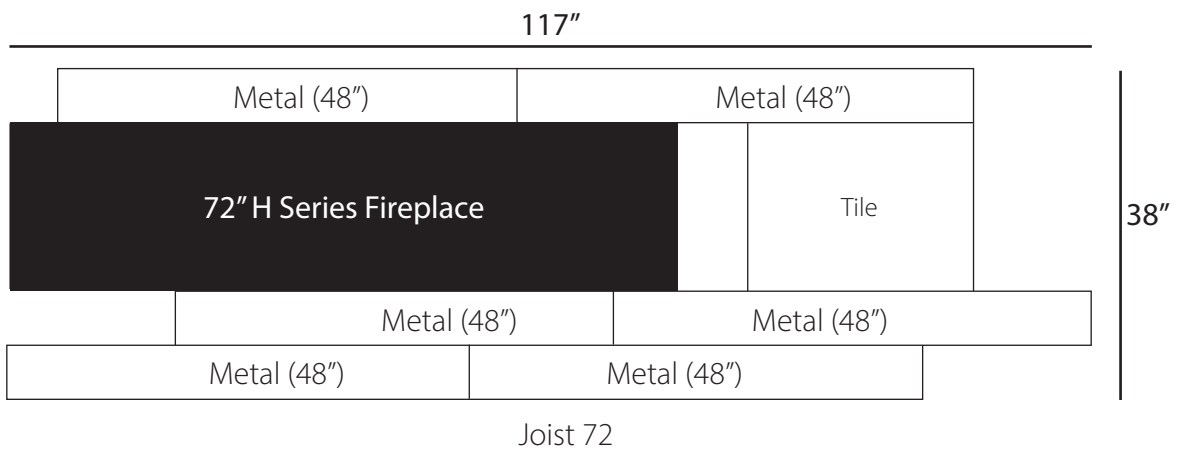
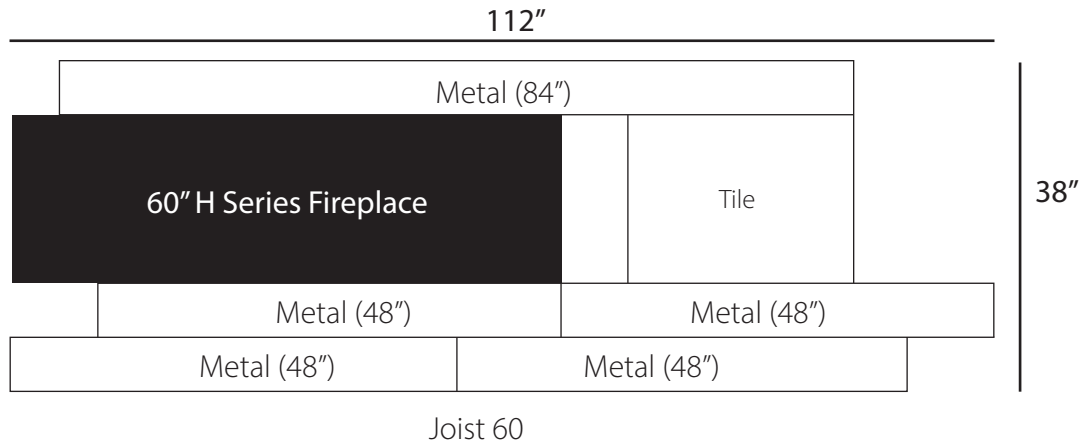
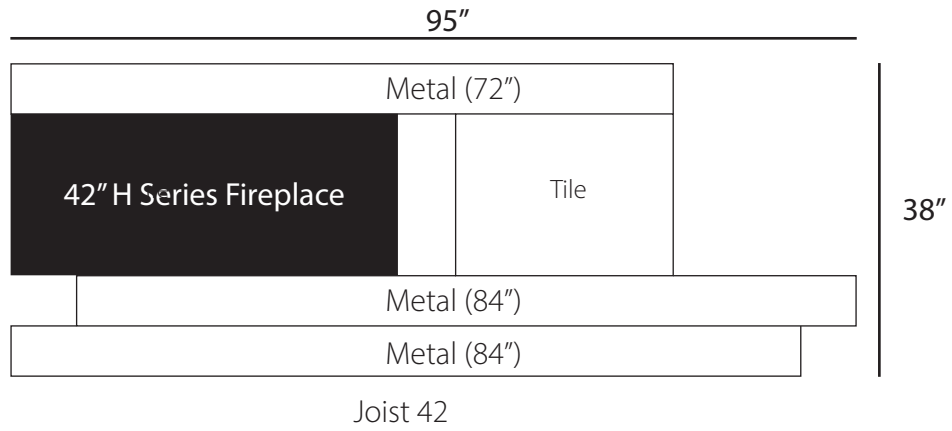

PRE-INSTALLATION PLANNING

BEFORE YOU BEGIN

These surrounds are intended to be installed in the same manor you would use a french cleat system. (See image below)

Please read these instructions thoroughly before proceeding. There is information which is important for safe and effective installation.

Please inspect your shipment for completeness and any damage. Contact your retailer if any damage is found. Do not install your surround with any damaged or substituted parts.

For the best finished results, please consider hiring a professional Carpenter or Contractor to install these surround panels. You can also refer to your dealer.

Before you begin your installation you should have the following tools and supplies:

- Gloves
- Pencil
- Impact Gun
- Drill
- Level
- Tape Measure and Framing Square
- Lint-free Cloth
- Stud-finder
- #8 Screws (Bugle Head)

Included with the Surround Panels:

- Various sized Z-Clips

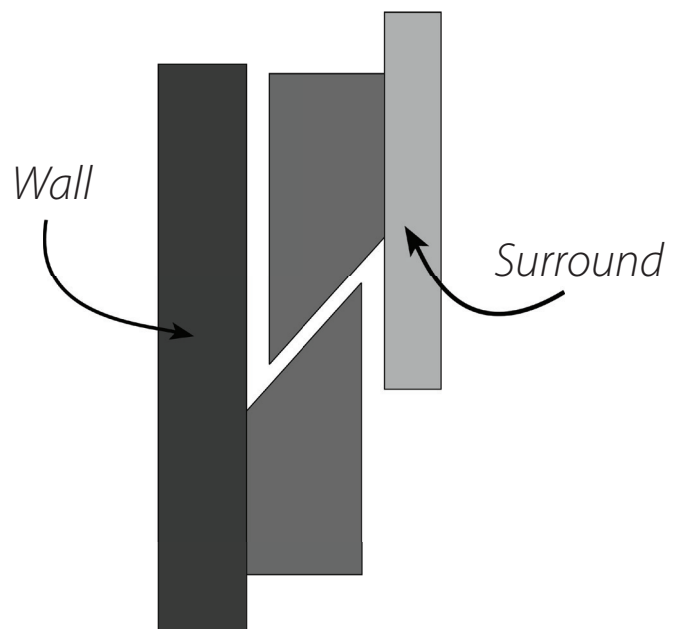

Detail of French Cleat Operation

INSTALLATION

LAYING OUT THE PANELS

The panels of the **Designer Surround for H Series** are made to fit against the fireplace opening and each other.

First, hold a metal panel up to the lower edge of the fireplace and mark the wall with a light pencil line along the lower edge of the metal panel(s). Then draw a straight line parallel to the right edge of the fireplace opening at the distance shown below as appropriate for your surround model. The intersection of these two lines is the starting point for the installation.

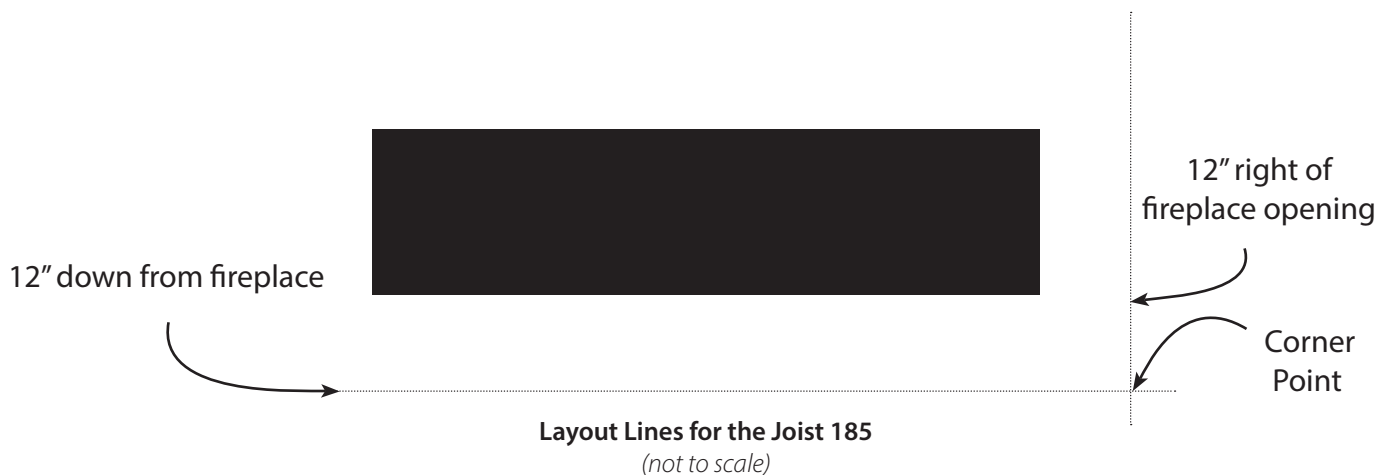
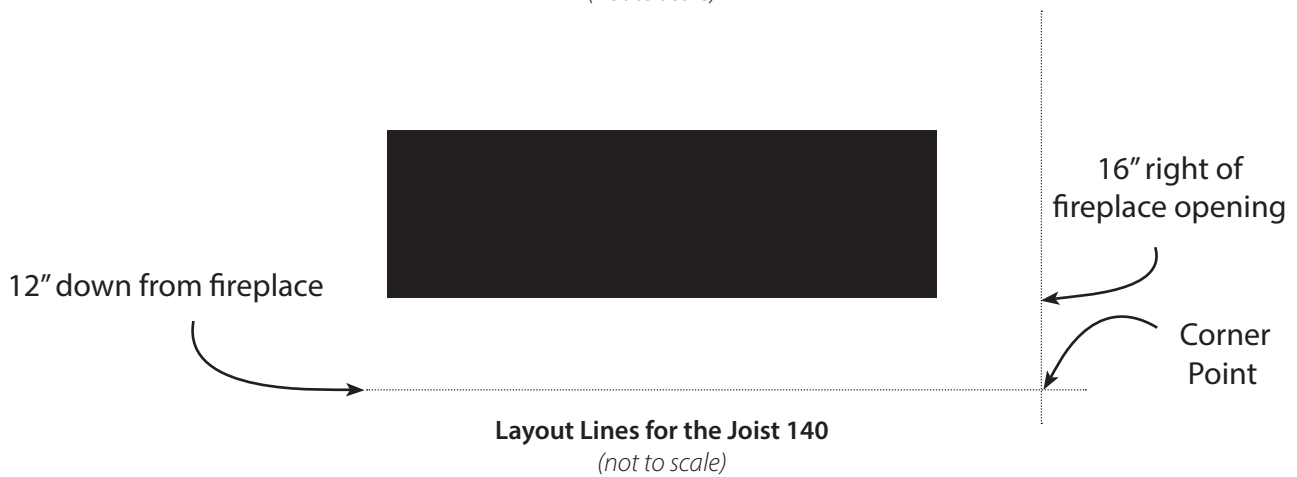
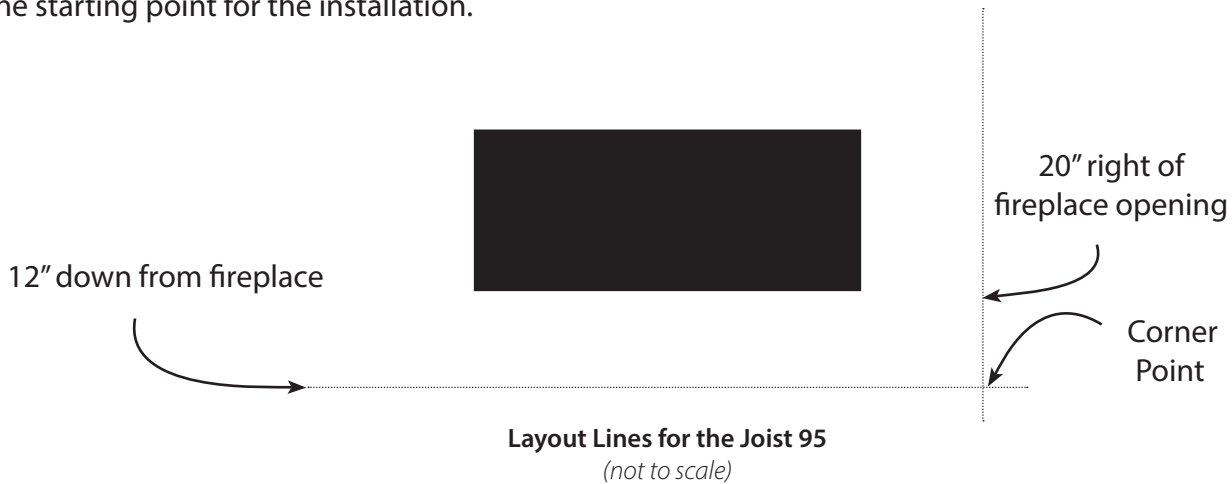

INSTALLATION: WALL LAYOUT

The metal panels and tile panels should be applied to the wall in the order shown below.

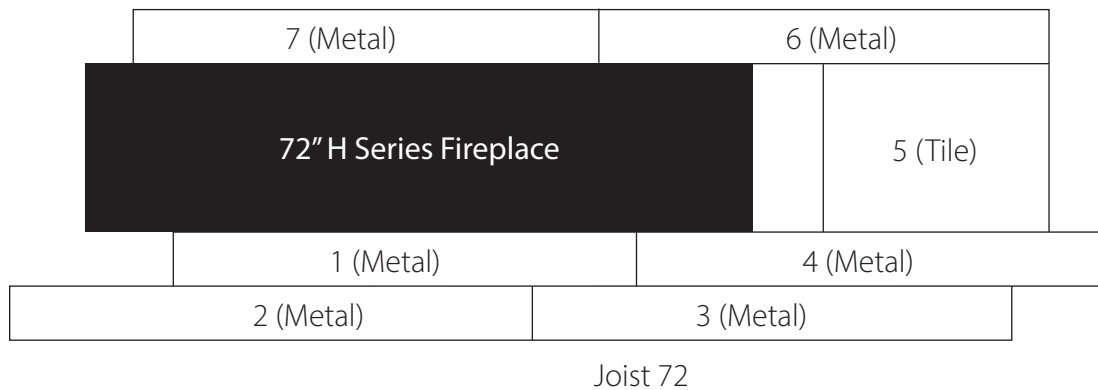
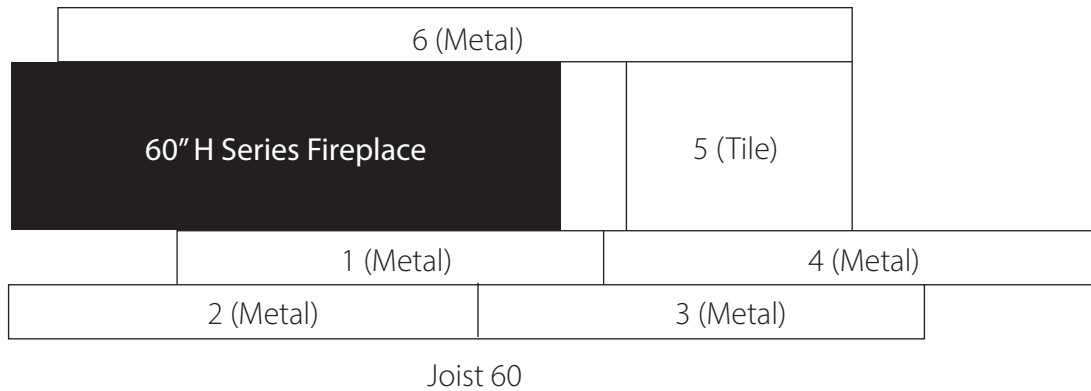
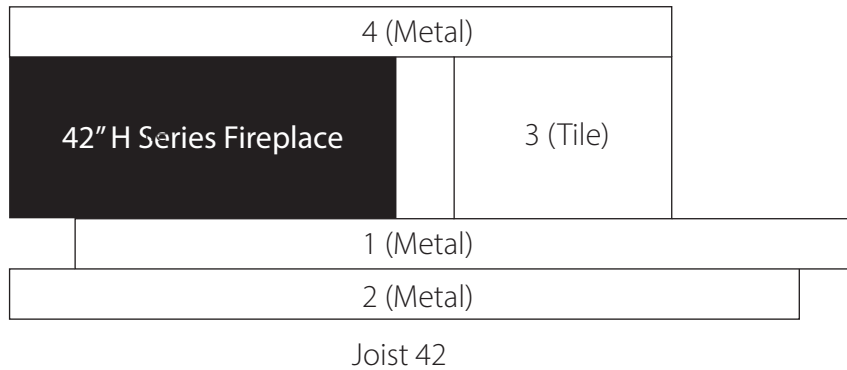

INSTALLATION: WALL LAYOUT + Z-CLIPS

NOTE ABOUT Z-CLIPS

Z-clips installed on the wall should have the interlocking side facing up. The slotted side of the clips face the wall. The length of the clips is to account for contact with the existing wall stud behind the wall sheeting. Mount the Z-clips to studs only.

Z-CLIP INSTALLATION PREP - REFER TO GRAPHICS ON PAGES 10-11

- Use a stud-finder to mark the stud locations above, below, and flanking the fireplace within the relevant area you will be installing the surround. Screw into these locations for structural integrity. Note, you can drill into the fireplace cabinet using 3/4" self tapping screws.
- The included z-clips should exceed 16" slightly. Holes are predrilled to 16" to line up with the rule of 16" on center. There should be center drilled holes as well.
- Before sinking the second screw, make sure you level the clip off along the guideline.

Ideal Stud Framing Example

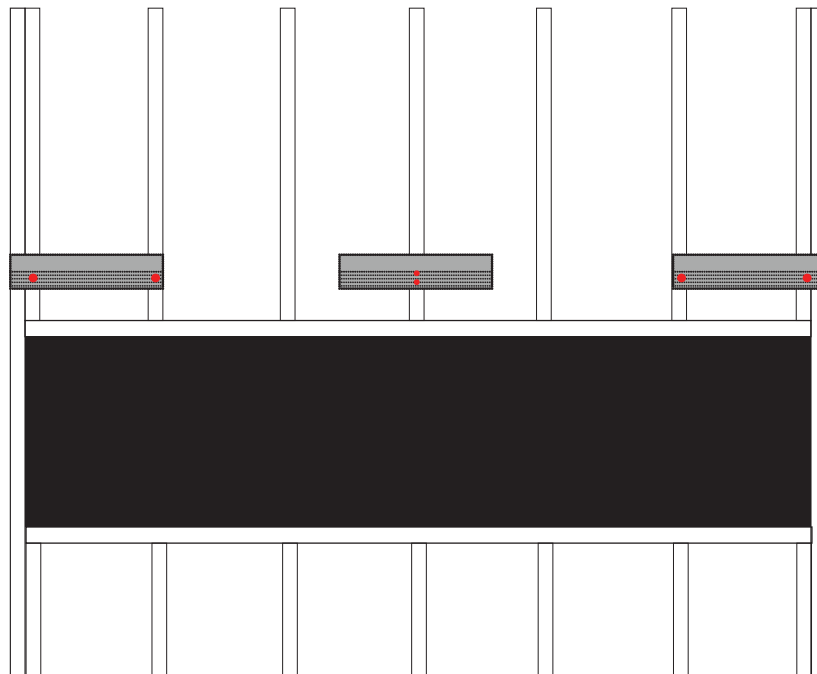

INSTALLATION: WALL LAYOUT

Using the starting point and the edges of the fireplace, mark lines on the wall using the measurements appropriate to your model, below.

Red lines Represent guidelines for Z-clip; draw these in as guides for mounting.

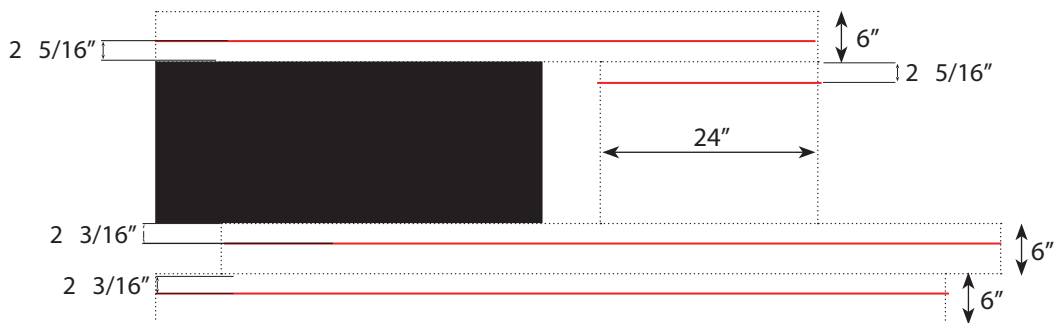

Layout Lines for the Joist 42
(not to scale)

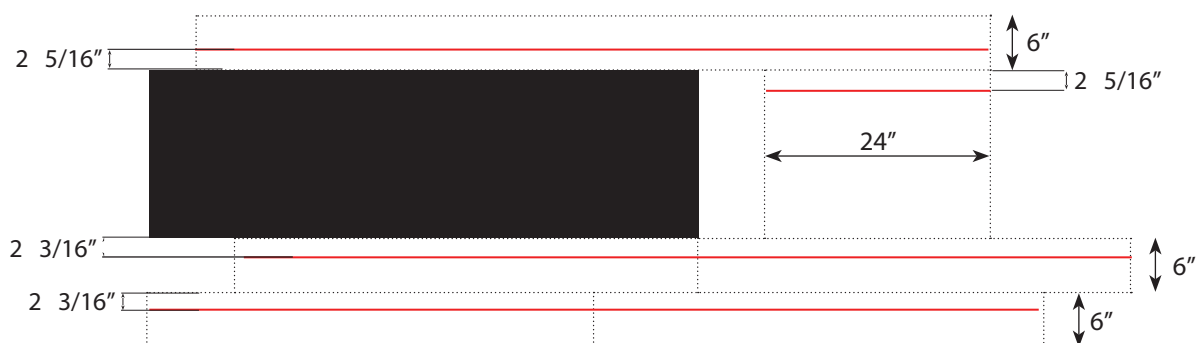

Layout Lines for the Joist 60
(not to scale)

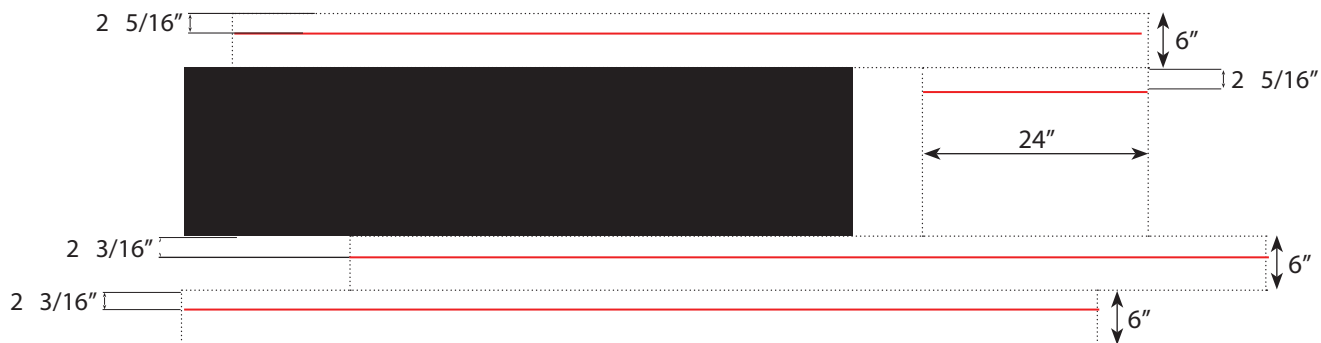

Layout Lines for the joist 72
(not to scale)

INSTALLATION

The areas in gray, below, show where the Z-clips is to be applied to the wall.

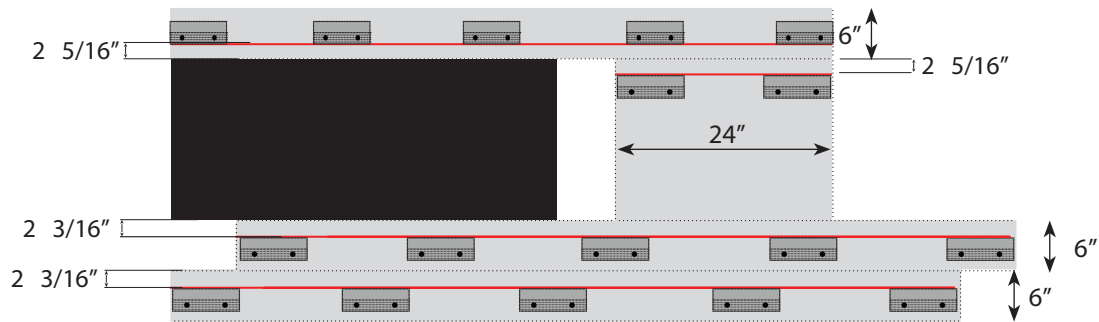

Align Z-Clips to the Red Lines

(42"- not to scale)

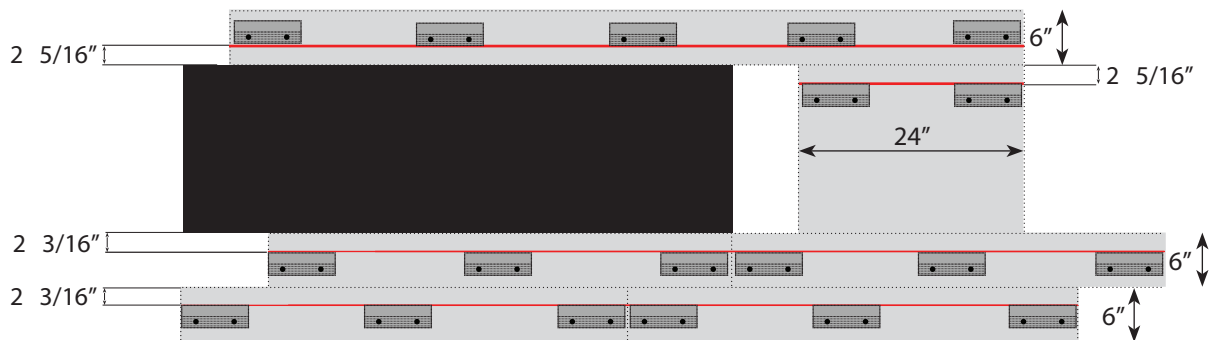

Align Z-Clips to the Red Lines

(60"- not to scale)

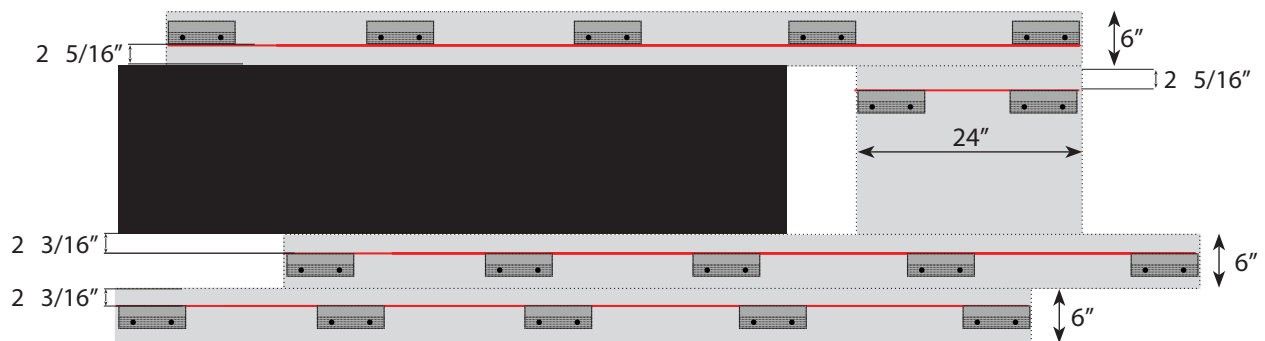

Align Z-Clips to the Red Lines

(72"- not to scale)

MAINTENANCE

SURROUND MAINTENANCE

Weekly Cleaning

Both the metal and tile panels should be wiped with a lint free cloth to remove any dust then wiped with a damp cloth.

WARRANTY

European Home Warranty

Designer Surround for H Series

European Home warrants this product against defects in materials and workmanship for a period of TWO (2) YEAR from the date of original retail purchase.

If a defect exists, European Home will, at its option, either (1) provide needed components using new or refurbished replacement parts or (2) exchange the product with one which is new or which has been manufactured from new or serviceable used parts and is at least functionally equivalent to the original product. A replacement product/part assumes the remaining warranty of the original product or ninety (90) days from the date of replacement or repair, whichever provides longer coverage for you. When a product or part is exchanged, any replacement item becomes your property and the replaced item becomes the property of European Home. All warranty claims must be submitted through the dealer from which you purchased the product. Check with your dealer in advance for any costs to you when arranging a warranty call. Shipping and/or delivery charges for parts are not covered by this warranty.

Nothing in the above shall be deemed to imply that this warranty shall apply to work which has been abused or neglected or shows evidence of changes or modifications by others with or without permit, damages caused by the acts of God, building settlement or moving, fire or vandalism. In addition, installation of this product that varies from the requirements stated in the instruction manual will void the warranty.



EuropeanHome

EUROPEAN HOME

a division of Europa Ja, Inc.
30 Log Bridge Road
Building 300 - Suite 303
Middleton, MA 01949
www.europeanhome.com