

# GAS STONES VENT FREE with FUSION BASKET Installation Guide



**This is an unvented gas-fired heater. It uses air (oxygen) from the room in which it is installed. Provisions for adequate combustion and ventilating air must be provided. Refer to page 6.**

**This heater may be installed in an aftermarket, permanently located, manufactured (mobile) home, where not prohibited by local codes.**

**This heater is only for use with the type of gas indicated on the rating plate. This heater is not convertible for use with other gases.**

**INSTALLER: Leave this manual with the heater.  
END USER: Retain this manual for future reference.**

**WARNING: If the information in these instructions is not followed exactly, a fire or explosion may result causing property damage, personal injury or loss of life.**

**Do not store or use gasoline or other flammable vapors and liquids in the vicinity of this or any other appliance.**

#### **WHAT TO DO IF YOU SMELL GAS**

- **Do not try to light any appliance.**
- **Do not touch any electrical switch; do not use any phone in your building.**
- **Immediately call your gas supplier from a neighbor's phone. Follow the gas supplier's instructions.**
- **If you cannot reach your gas supplier, call the fire department. Installation and service must be performed by a qualified installer, service agency or the gas supplier.**

**Installation and service must be performed by a qualified installer, service agency or the gas supplier.**



OMNI-Test Laboratories, Inc.

Report Number 284-L-04-5

## **TABLE OF CONTENTS**

Important Safety Information	3
Specifications and Dimensions	9
Fireplace Requirements	10
Installing the Burner	12
Gas Supply	12
Stone Configuration	14
Operating Instructions	16
Maintenance	18
Troubleshooting	19
Parts List	21

## IMPORTANT SAFETY INFORMATION

Read these instructions carefully before installing or trying to operate this Vent Free gas heater.

### WARNING

- **Any change to this heater or its controls can be dangerous.**
- **Improper installation or use of the heater can cause serious injury or death from fire, burns, explosion or carbon monoxide poisoning.**
- **Do not allow fans to blow directly into the fireplace. Avoid any drafts that alter burner flame patterns.**
- **Do not use a blower insert, heat exchanger insert or other accessory, not approved for use with this heater where applicable.**

1. Due to high temperatures, the heater should be located out of traffic and away from furniture and draperies.
2. Children and adults should be alerted to the hazard of high surface temperature and should stay away to avoid burns or clothing ignition.
3. Young children should be carefully supervised when they are in the same room with the heater.
4. Do not place clothing or other flammable material on or near the heater.
5. Any safety screen or guard removed for servicing a heater, must be replaced prior to operating the heater.
6. Installation and repair should be done by a qualified service person.
7. To prevent malfunction and/or sooting, an unvented gas heater should be cleaned before use and at least annually by a professional service person. More frequent cleaning may be required due to excessive lint from carpeting, bedding material, etc. It is imperative that control compartments, burners and circulating air passageways be kept clean.
8. **CARBON MONOXIDE POISONING:** Early signs of carbon monoxide poisoning are similar to the flu with headaches, dizziness and/or nausea. If you have these signs, obtain fresh air immediately. Have the heater serviced as it may not be operating properly.
9. The installation must conform with local codes or, in the absence of local codes, with the **National Fuel Gas Code, ANSI Z223.1/NFPA54.**
10. This unit complies with ANSI Z21.11.2-2007 Unvented Heaters.

## IMPORTANT SAFETY INFORMATION

Read these instructions carefully before installing or trying to operate this Vent Free gas heater.

11. Do not install the heater in a bathroom or bedroom.
12. Correct installation of the ceramic stones, proper location of the heater, and annual cleaning are necessary to avoid potential problems with sooting. Sooting, resulting from improper installation or operation, can settle on surfaces outside the fireplace. See stone placement instructions for proper installation.
- 13. WARNING:** Avoid any drafts that alter burner flame patterns. Do not allow fans to blow directly into fireplace. Do not place a blower inside burn area of firebox. Ceiling fans may create drafts that alter burner flame patterns. Sooting and improper burning will occur.
- 14. Caution:** Candles, incense, oil lamps, etc. produce combustion by-products including soot. Vent Free heaters will not filter or clean soot produced by these types of products. In addition, the smoke and/or aromatics (scents) may be reburned in the Vent Free heater which can produce odors. It is recommended to minimize the use of candles, incense, etc. while the Vent Free heater is in operation.
15. Keep room area clear and free from combustible materials, gasoline and other flammable vapors and liquids.
16. Unvented gas heaters are a supplemental zone heater. They are not intended to be the primary heating appliance.
17. Unvented gas heaters emit moisture into the living area. In most homes of average construction, this does not pose a problem. In houses of extremely tight construction, additional mechanical ventilation is recommended.
18. During manufacturing, fabricating and shipping, various components of this appliance are treated with certain oils, films or bonding agents. These chemicals are not harmful but may produce annoying smoke and smells as they are burned off during the initial operation of the heater; possibly causing headaches or eye or lung irritation. This is a normal and temporary occurrence. The initial break-in operation should last two to three hours with the burner at the highest setting. Provide maximum ventilation by opening windows or doors to allow odors to dissipate. Any odors remaining after this initial break-in period will be slight and will disappear with continued use.
19. Input ratings are shown in BTU per hour and are for elevations up to 2,000 feet. For elevations above 2,000 feet, input ratings should be reduced 4 percent for each 1,000 feet above sea level. Refer to the National Fuel Gas Code.
20. The heater and its main gas valve must be disconnected from the gas supply piping system during any pressure testing of that system at test pressures in excess of ½ psig (3.5 kPa).

## IMPORTANT SAFETY INFORMATION

Read these instructions carefully before installing or trying to operate this Vent Free gas heater.

21. The appliance must be isolated from the gas supply piping system by closing its equipment shutoff valve during any pressure testing of the gas supply piping system at test pressures equal to or less than ½ psi (3.5 kPa).
22. Do not use this room heater if any part has been under water. Immediately call a qualified service technician to inspect the room heater and to replace any part of the control system and any gas control which has been under water.
23. This heater must not be used with glass doors in the closed position. This can lead to pilot outages and severe sooting outside the fireplace.
24. Never burn solid fuels in a fireplace where an unvented room heater is installed.
25. Always have a fireplace screen in place when the appliance is in operation and, unless other provisions for combustion air are provided, the screen must have an opening(s) for induction of combustion air.
26. All outside air ducts and/or ash dumps in the fireplace must be permanently closed prior to the installation of the heater.
27. This appliance has been certified by OMNI-Test Laboratories, Inc. to ANSI Z21.11.2-2007, "Standard for Gas-Fired Room Heaters, Volume II, Unvented Room Heaters."
28. This appliance is approved for installation in the Commonwealth of Massachusetts. The Board of State Examiners of Plumbers and Gas Fitters has issued approval number G3-0311-479 for this appliance.

### WARNING

**This appliance is for installation in a solid-fuel burning fireplace or UL 127 factory-built fireplace or in a listed ventless firebox enclosure.**

**Exception: DO NOT install this appliance in a factory-built fireplace that includes instructions stating that it has not been tested or should not be used with unvented gas logs.**

## GENERAL INSTALLATION INFORMATION

### CODES

Adhere to all local codes or, in their absence, the latest edition of THE NATIONAL FUEL GAS CODE ANSI Z223.1 or NFPA54 which can be obtained from...

American National Standards Institute, Inc.  
1430 Broadway  
New York, NY 10018  
or  
National Fire Protection Association, Inc.  
Batterymarch Park  
Quincy, MA 02269

### ADEQUATE COMBUSTION AND VENTILATION AIR

This heater shall not be installed in a confined space or unusually tight construction unless provisions are provided for adequate combustion and ventilation air.

The National Fuel Gas Code, (ANSI Z223.1/NFPA 54), defines a *confined* space as a space whose volume is less than 50 cubic feet per 1,000 BTU per hour (4.8 m<sup>3</sup> per kw) of the aggregate input rating of all appliances installed in that space. An *unconfined* space is defined as a space whose volume is not less than 50 cubic feet per 1,000 BTU per hour (4.8 m<sup>3</sup> per kw) of the aggregate input rating of all appliances installed in that space. Rooms communicating directly with the space in which the appliances are installed, through openings not furnished with doors, are considered a part of the unconfined space.

### UNUSUALLY TIGHT CONSTRUCTION IS DEFINED AS CONSTRUCTION WHERE...

a) walls and ceilings exposed to the outside atmosphere have a continuous water vapor retarder with a rating of 1 perm (6 x 10<sup>-11</sup> kg per pa-sec-m<sup>2</sup>) or less with openings gasketed or sealed;

b) weather stripping has been added on operable windows and doors, and

c) caulking or sealants are applied to areas such as joints around window and door frames, between sole plates and floors, between wall-ceiling joints, between wall panels, at penetrations for plumbing, electrical, and gas lines, and at other openings.

**WARNING**

**This appliance is equipped for natural gas.  
Field conversion is not permitted.**

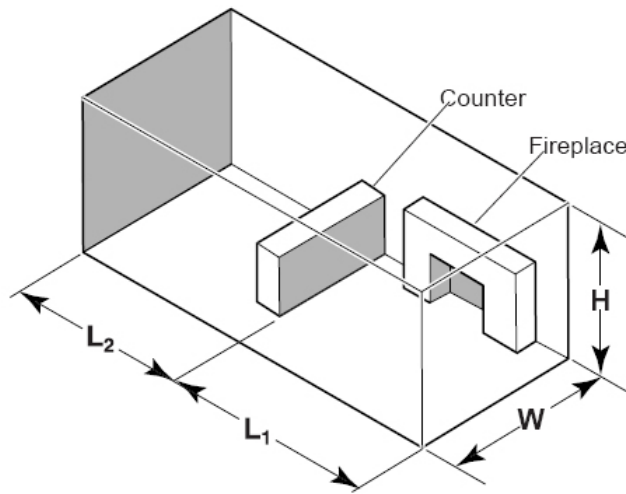

The following formula can be used to determine the maximum heater rating (per the definition of unconfined space) that is allowed in your space:

$$\text{Maximum BTU/Hr.} = \frac{(L1 + L2)\text{ft.} \times (W)\text{ft.} \times (H)\text{ft.}}{50} \times 1000$$

Example A: Consider two connecting rooms with an open area between, with the following dimensions: L1 = 15½ ft., L2 = 12 ft., W = 12 ft., H = 8 ft.

$$\frac{(15\frac{1}{2} + 12)\text{ft.} \times (12)\text{ft.} \times (8)\text{ft.}}{50} \times 1000 = 52,800 \text{ BTU/Hr.}$$

Example B: If there were a door between the two rooms the calculation would be based only on the room with the heater.

$$\frac{(15\frac{1}{2})\text{ft.} \times (12)\text{ft.} \times (8)\text{ft.}}{50} \times 1000 = 29,760 \text{ BTU/Hr.}$$

**Will my space support a Gas Stones Vent Free with Fusion Basket?**

Maximum BTU/hr. my space will support (use formula above) 1) \_\_\_\_\_

BTU/hr. of European Home Gas Stones Vent Free 2) 39,000

If the answer to 1) is **greater** than 2) then your space **will** support the installation of the Gas Stones Vent Free; if 1) is **less** than 2) then your space **will not** support a Gas Stones Vent Free.

WARNING	<p><b>If the area in which the heater may be operated is smaller than that defined as an unconfined space or if the building is of unusually tight construction, provide adequate combustion and ventilation air by one of the methods described in the National Fuel Gas Code, ANSI Z223.1/NFPA 54, Section 5.3 or applicable local codes.</b></p>
---------	---

## Vision Vent Free Gas Burner Module

S/N NG- \_\_\_\_\_ E \_\_\_\_\_

This appliance is equipped for Natural Gas.

Input Rating Btu/hr	39,000
Min. Input (Btu/hr)	27,000
Orifice (DMS)	6 Port #55
Manifold Press.	3.5"/0.87kPa
Min. Supply Press.	4.0"/1.0kPa
Max. Supply Press.	7.0"/1.7kPa
Type of Control	Maxitrol GV60 Gas Control

Tested & Listed By  Portland Oregon USA

OMNI-Test Laboratories, Inc.  
Report #284-F-03-5  
& 284-L-04-5

Manufactured by  
European Home, Inc.  
Malden, MA 02148  
(781) 324-8383

This burner module is certified by OMNI-Test Laboratories to ANSI Z21.11.2-2007 *Unvented Heaters*, when installed in the Vision Vent Free Gas Fireplace or the Gas Stones Vent Free With Fusion Basket. Removal of this marking will void compliance of this heater with ANSI Z21.11.2.

This appliance must be installed in accordance with local codes, if any; if none, follow the ANSI Z223.1. Installation and service must be performed by a qualified installer, service agency or the gas supplier. This appliance shall not be field converted.

**WARNING:** This appliance is for installation only in a solid-fuel burning masonry or UL 127 factory-built fireplace or in a listed ventless firebox enclosure. It has been design certified for these installations. Exception: DO NOT install this appliance in a factory-built fireplace that includes instruction stating it has not been tested or should not be used with unvented gas logs.

**WARNING:** Do not use a blower insert, heat exchanger insert or other accessory not approved for use with this heater.

**WARNING:** Fireplace screens must be closed while the appliance is in operation. Any glass doors must be completely open while the appliance is in operation.

This heater shall not be installed in a bedroom or bathroom.

This appliance is intended for supplemental heating.

**WARNING:** Failure to position the parts in accordance with these diagrams or failure to use only parts specifically approved with this heater may result in property damage or personal injury. See instructions manual for further information.

Apply loose material per instructions manual. DO NOT apply extra material or material not supplied with the heater. Replace only with European Home Stone Kit Part Number VPK-01.



This appliance may be installed in an aftermarket, permanently located, manufactured (mobile) home, where not prohibited by local codes.  
This appliance is only for use with the type of gas indicated on the rating plate. This appliance is not convertible for use with other gases.

**WARNING:** Improper installation, adjustment, alteration, service or maintenance can cause property damage, personal injury or loss of life. Refer to the owner's information manual provided with this appliance. Installation and service must be performed by a qualified installer, service agency, or the gas supplier.

**CAUTION:** Hot while in operation. Do not touch. Severe burns may result. Keep children, clothing, furniture, gasoline and other liquids having flammable vapors away.

**WARNING:** When used without adequate combustion and ventilation air, heater may give off excessive CARBON MONOXIDE, an odorless, poisonous gas.

DO NOT INSTALL HEATER UNTIL ALL NECESSARY PROVISIONS ARE MADE FOR COMBUSTION AND VENTILATION AIR. CONSULT THE WRITTEN INSTRUCTIONS PROVIDED WITH THE HEATER FOR INFORMATION CONCERNING COMBUSTION AND VENTILATION AIR. IN THE ABSENCE OF INSTRUCTIONS, REFER TO THE NATIONAL FUEL GAS CODE, ANSI Z223.1, OR APPLICABLE LOCAL CODES.

This heater is equipped with a PILOT LIGHT SAFETY SYSTEM designed to turn off the heater if not enough fresh air is available.

**DO NOT TAMPER WITH THE PILOT LIGHT SAFETY SYSTEM!**

If heater shuts off, do not relight until you provide fresh air.

If heater keeps shutting off, have it serviced. Keep burner and control compartment clean.

**CARBON MONOXIDE POISONING MAY LEAD TO DEATH.**

Early signs of carbon monoxide poisoning resemble the flu, with headache, dizziness and/or nausea. If you have these signs, heater may not be working properly. Get fresh air at once! Have heater serviced.

IGN

Listing Plate for Gas Stones Vent Free Natural Gas Burner

## SPECIFICATIONS and DIMENSIONS

Fuel Type:	Natural Gas ONLY
Manifold Pressure:	3.5" (0.87 kPa)
Minimum Supply Pressure:	4.0" (1.0 kPa)
Maximum Supply Pressure:	7.0" (1.7 kPa)
Orifice Size:	6 Port #55 DMS
Input:	High Fire - 39,000 BTU/hr. Low Fire - 27,000 BTU/hr.
Length:	24 in (60.9 cm)
Depth:	12 in (30.4 cm)
Height:	6¾ in (17.1 cm)

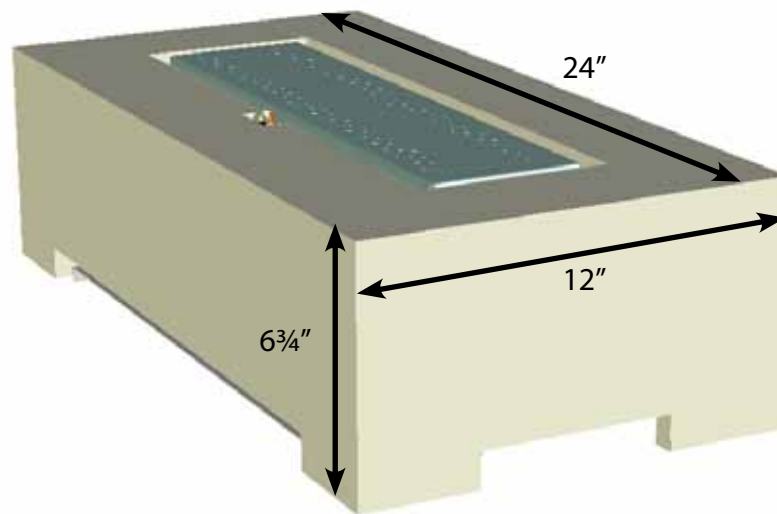

**Figure 1**

# FIREPLACE REQUIREMENTS

Your Gas Stones Vent Free with Fusion Basket is for installation in a solid-fuel burning fireplace or UL 127 factory-built fireplace or in a listed ventless firebox enclosure.

Exception: DO NOT install this appliance in a factory-built fireplace that includes instructions stating that it has not been tested or should not be used with unvented gas logs.

When installed in a vented fireplace your Gas Stones Vent Free with Fusion Basket must sit fully inside the fireplace so that it properly drafts up the chimney flue.

In all cases, be **certain** that the burner of your Gas Stones Vent Free with Fusion Basket is **behind the fireplace lintel**. (see Figure 2)

**WARNING:** Before installing in a solid-fuel burning fireplace, the chimney flue and firebox must be cleaned of soot, creosote, ashes and loose paint by a qualified chimney cleaner.

**Figure 2**

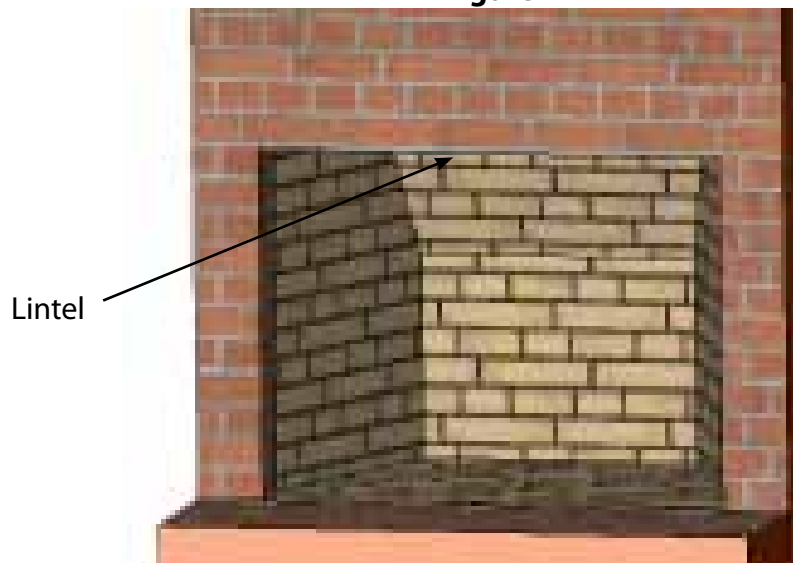

MANTEL CLEARANCES

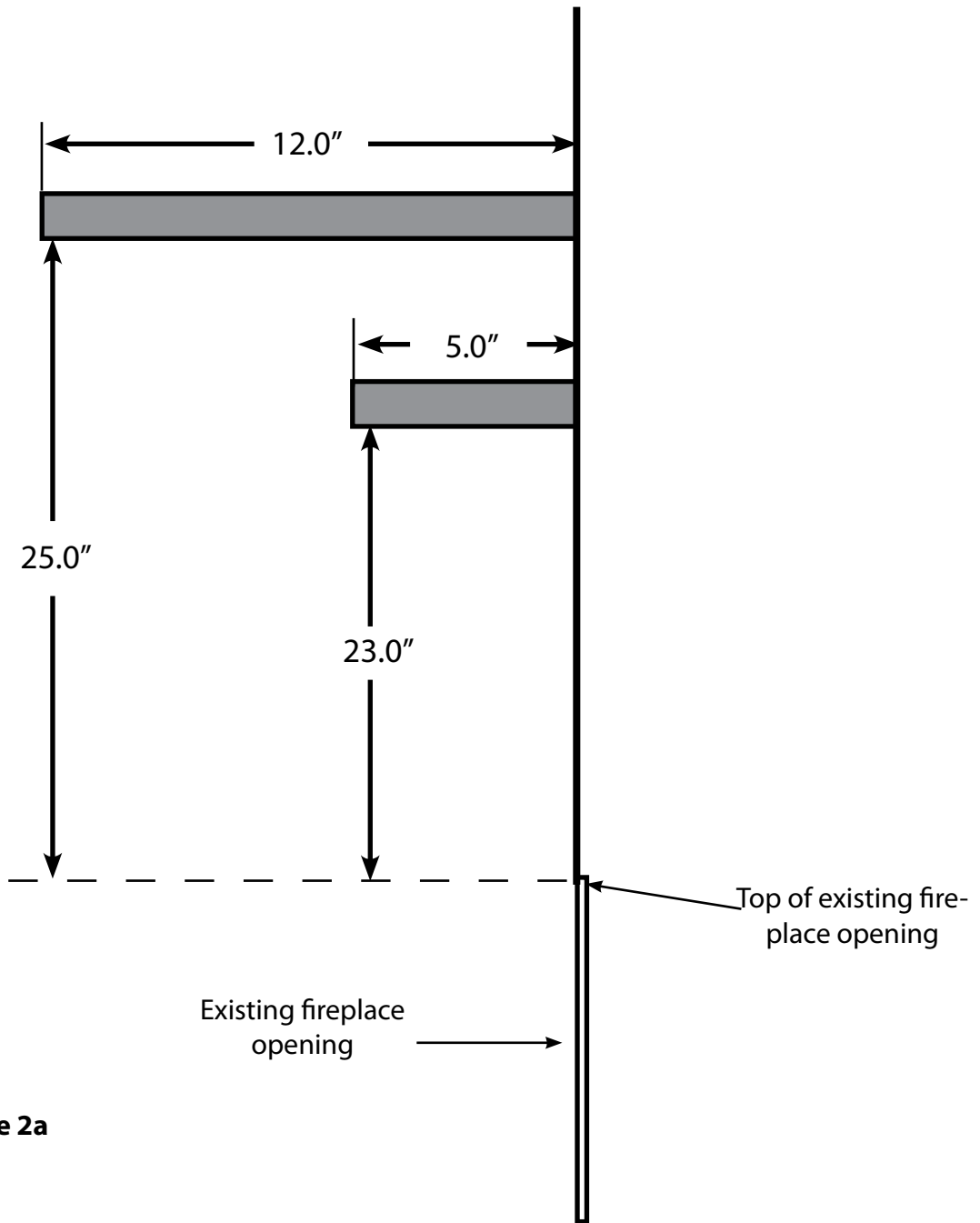
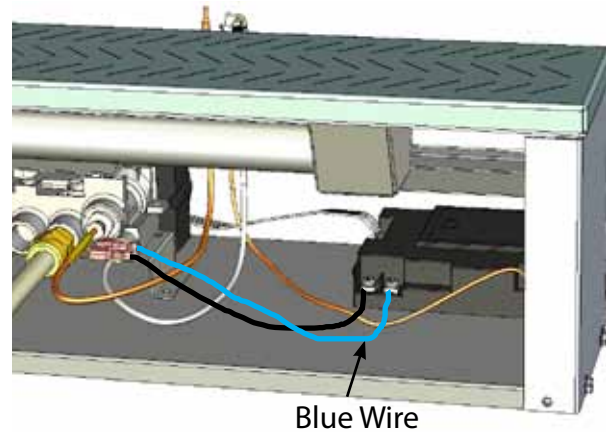

Figure 2a

Combustible mantels may be no closer to the fireplace opening than the distances shown in the Figure 2a side view, above.

## INSTALLING THE BURNER

Connect the blue wire to the control module and thermocouple lead as shown in Figure 3.



**Figure 3**

## GAS SUPPLY

The gas supply should terminate within three inches (3") of the rear of the burner module. In this way the gas supply can be hidden under the Fusion Basket.

Place the burner module in the center of the fireplace and connect the gas supply to the flexible gas supply connector provided with the burner. The gas supply line must terminate with a male ½" NPT pipe thread in the rear of the fireplace. The gas supply piping should have a separate gas shutoff valve and a ⅛" NPT plugged tapping up stream of the valve.



**Figure 4**

The Gas Stones Vent Free with Fusion Basket and its main control valve must be disconnected from the gas supply piping system during any pressure testing of that system at test pressures in excess of ½ psi (3.5 kPa).

The Gas Stones Vent Free with Fusion Basket must be isolated from the gas supply piping system by closing the main control valve during any pressure testing of the gas supply system at test pressures equal to or less than ½ psi (3.5 kPa).

After the gas supply has been connected, open the main supply and apply a soapy water solution to all the fittings to check for gas leaks. **Never use a flame to test for leaks.** Ensure that the burner inlet tube is in the shutter box.



**Figure 5**

Place the Fusion Basket over the burner so the burner is centered in the opening in the Fusion Basket as in Figure 5.

**WARNING:** Failure to position the parts in accordance with these diagrams or failure to use only parts specifically approved with this heater may result in property damage or personal injury.

## STONE CONFIGURATION

The Gas Stones Vent Free with Fusion Basket can be operated with, or without, the decorative stones and/or the embers. The following is the recommended stone/ember configuration. Slight differences in the placements are acceptable.

When using the stones and embers, begin by placing one layer of the embers evenly over the entire burner top as shown in Figure 6.



**Figure 6**

Sort your stones, by size, into sixteen small, three medium and four large. Place a row of six small stones along the rear edge of the burner as shown in Figure 7.



**Figure 7**

Next, place two large stones and three small stones on the burner as shown in Figure 8. Then place two medium and four small stones along the front edge of the burner as shown in Figure 9.



**Figure 8**

Finally, place the remaining two large, one medium and three small stones on top as shown in Figure 9.



**Figure 9**

Figure 10 shows a completed installation of stones.

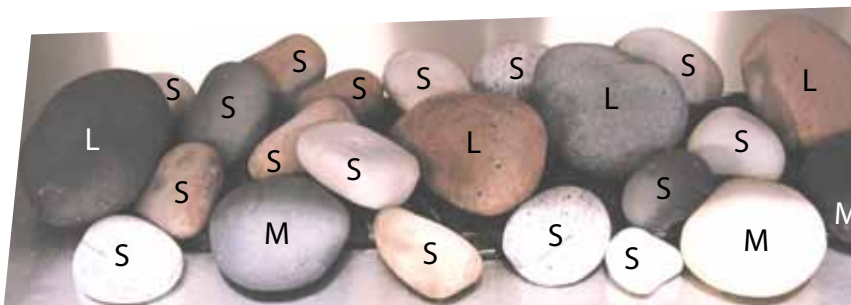

**Figure 10**

## WARNING

The stones installation must be per these instructions. This heater must use only the stones provided by European Home. An excess amount of stones may adversely affect the performance of the heater. All previously applied loose material must be removed prior to reapplication.

# OPERATING INSTRUCTIONS

## FOR YOUR SAFETY READ BEFORE LIGHTING!

**WARNING:** If you do not follow these instructions exactly, a fire or explosion may result causing property damage, personal injury or loss of life.

A. This heater is equipped with an ignition device which automatically lights the pilot. Do not try to light the pilot by hand.

B. BEFORE LIGHTING smell all around the heater area for gas. Be sure to smell next to the floor because some gas is heavier than air and will settle on the floor.

### WHAT TO DO IF YOU SMELL GAS

- Do not try to light any appliance.
- Do not touch any electric switch; do not use any phone in your building.
- Immediately call your gas supplier from a neighbor's phone. Follow the gas supplier's instructions
- If you cannot reach your gas supplier, call the fire department.

C. Do not use this heater if any part has been under water. Immediately call a qualified service technician to inspect the heater and to replace any part of the control system and any gas control which has been under water.

## LIGHTING THE FIRE

1. STOP! Read the safety information above.
2. This heater is equipped with an ignition device which automatically lights the pilot. Do not try to light the pilot by hand.
3. Push the OFF button on the remote control to insure the heater is off.
4. Wait five (5) minutes to clear out any gas. Then smell for gas including near the floor. If you smell gas, STOP! Follow "B" in the safety information above. If you don't smell gas, go to the next step.
5. Press the **OFF** and **▲** buttons simultaneously. Release the buttons once you hear the beeping begin. This signal tells you that the ignition sequence has begun. Further short beeps will continue until main gas flows and the burner is lit. If the pilot or burner does not light, go back to Step 3, above.
6. Use the up and down arrows to adjust the flame height.

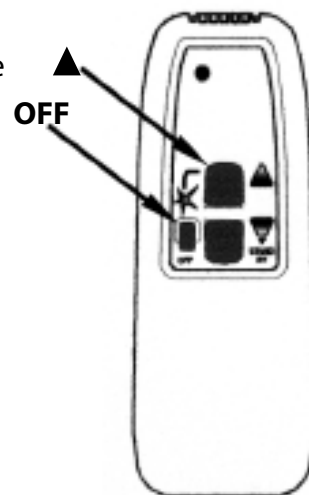

## TO TURN OFF THE HEATER

Push the **OFF** button on the remote control to turn the heater off.

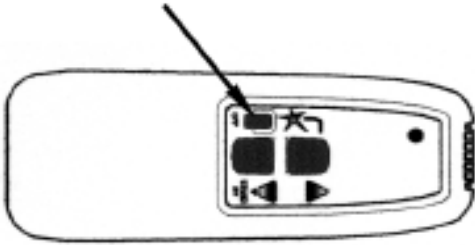

## RESETTING THE SYSTEM

To reset the system:

1. press and hold the receiver reset button until you hear the second of two beeps then
2. release the reset button and, within twenty seconds,
3. press the down button on the remote until you hear a confirming beep

The receiver and remote are now each reset and ready for normal operation.

# MAINTENANCE

A qualified service agency should conduct an annual inspection and maintenance of your Gas Stones Vent Free with Fusion Basket, the fireplace, chimney, and the installation to keep it running safely. The following procedures should be performed only by a qualified service person. The gas supply should be turned off whenever a maintenance procedure is performed. All parts of the fireplace that are removed for servicing must be replaced prior to operation.

## **Cleaning the Stones and Burner.**

With all parts of the fireplace at room temperature, carefully remove and clean the stones with a soft bristled brush. Never use a vacuum cleaner to clean the stones. Clean the burner surface with a brush. Replace the components per the instructions starting on page 11 of this manual.

**WARNING:** Failure to keep the primary air opening of the burner clean may result in sooting and property damage.

## **Inspecting the Chimney**

An inspection of the chimney should be made as part of the annual service appointment. The chimney must have no blockage and be in good repair.

## **Replacing the Batteries**

With all parts of the fireplace at room temperature, remove the stones and embers. Remove the Fusion Basket from the fireplace. Remove the battery compartment door from the receiver and replace the old batteries with four, new, high quality AA alkaline batteries.

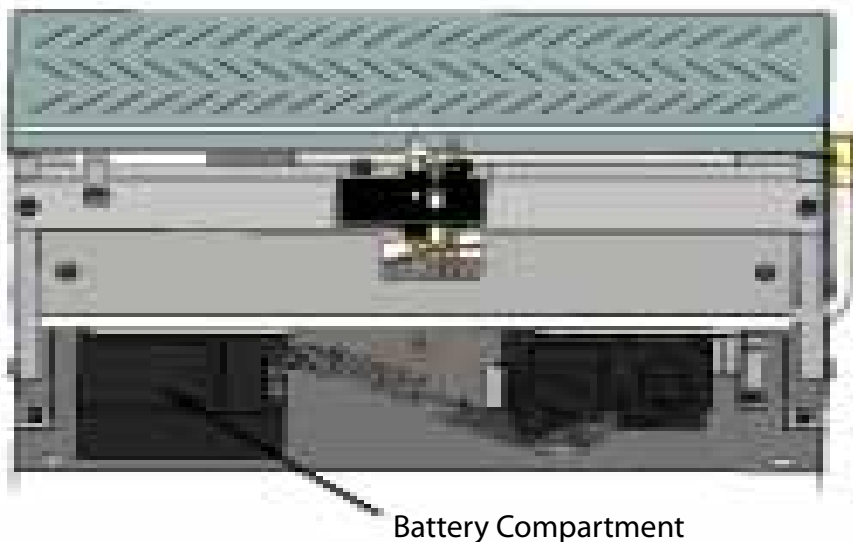

**Figure 10**

# TROUBLESHOOTING

OBSERVED PROBLEM:	POSSIBLE CAUSE:	REMEDY:
<b>A.</b> No transmission (motor does not turn)	1. Receiver must learn new code.	1. Reset system as above.
	2. Dead batteries.	2. Replace batteries.
	3. The receiver is surrounded by metal, reducing the transmission range.	3. Change the position of the antenna.
	4. Receiver	4. Replace receiver and reprogram code as above.
	5. Transmitter	5. Replace the transmitter and reprogram code as above.
	6. Wiring at valve damaged.	6. Replace valve.
	7. Bent pins on 8 wire connector.	7. Straighten pins on 8 wire connector.
<b>B.</b> No ignition; no tone	1. Dead batteries.	1. Replace batteries.
	2. Receiver	2. Replace the transmitter and reprogram code as above.
<b>C.</b> No ignition; one 5 second continuous tone (7 short beeps might be heard prior to the 5 second tone)	1. ON/OFF switch is in OFF position.	1. Push switch to ON position.
	2. Loose wire.	2. Secure wire.
	3. Receiver	3. Replace receiver and reprogram code as above.
	4. Bent pins on 8 wire connector.	4. Straighten pins on 8 wire connector.
	5. Valve	5. Replace valve.
<b>D.</b> No pilot flame and control continues to spark	1. Air in the pilot supply line.	1. Purge the line or start ignition several times.
	2. No spark at pilot burner.	2. Check spark gap; check wiring connection. Check for spark in location along cable.
	3. Valve	3. Replace valve. Do not over tighten the thermocouple.

OBSERVED PROBLEM:	POSSIBLE CAUSE:	REMEDY:
<b>D.</b> No pilot flame and control continues to spark	4. Over tightened thermocouple.	4. Replace valve and thermocouple interrupter.
	5. Receiver	5. Replace receiver and reprogram code as above.
<b>E.</b> Pilot is lit and control continues to spark. Valve shuts off after 10-30 seconds. Valve operates manually.	1. Receiver	1. Replace receiver and reprogram code as above.
<b>F.</b> Pilot is lit and sparking stops. Valve shuts off after 10-60 seconds. Valve does not operate manually.	1. Not enough voltage generated from the thermocouple or too much resistance in the circuit.	1. Use a digital multimeter set in the mV range and measure the voltage between the spade connector closest to the thermocouple (-) and thermocouple tube (+) itself. The reading should be 21-30 mV.
	2. Thermocouple	2. Replace thermocouple.
	3. Low inlet pressure.	3. Confirm regulator pressure and sizing. Replace if necessary.
	4. Valve	4. Replace valve. Do not over-tighten the thermocouple.
<b>G.</b> Three short beeps while the motor turns.	1. Batteries are low.	1. Replace batteries.
<b>H.</b> Pilot flame lights but there is no main gas flow.	1. Manual override knob is in MAN position.	1. Turn manual override knob to ON position (see figure 4).
	2. Valve turned down to pilot flow.	2. Turn flame to high fire by pressing up button on remote control.
	3. Low inlet pressure.	3. Confirm regulator pressure, and sizing. Replace valve if necessary.
	4. Valve.	4. Replace valve.



Make a periodic visual inspection of the pilot and main burner flames.  
The flames should look similar to those in the picture above.

## **PARTS LIST**

Burner Module, NG	GS-VF-BM-NG-01
Stone Kit	V-VF-PK-01
Pilot Assembly	V-VF-PA-01
Fusion Basket	V-SB-01

For replacement parts and customer service, contact:

### **EUROPEAN HOME**

+1 (781) 324-8383

**EUROPEAN HOME**

a division of Europa Ja, Inc.

376 Washington St.

Suite 203

Malden, MA 02148

tel: 781/324-8383

fax: 781/324-8384

[www.europeanhome.com](http://www.europeanhome.com)